

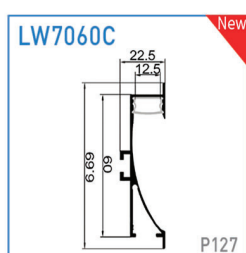

## 1.6

## WATERPROOF PROFILE

Waterproof products can be used for bathroom, fountain, refrigerator and other special occasions with water.

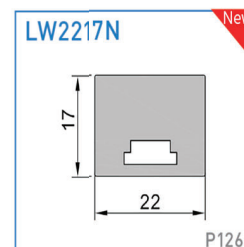
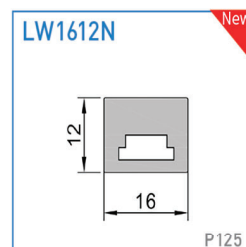
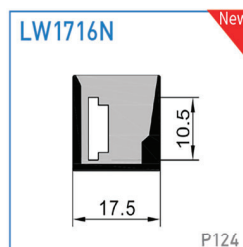
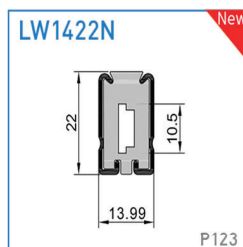
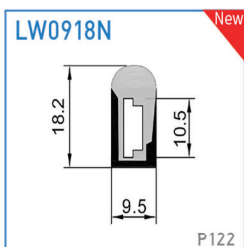

# WATERPROOF LED Profile

Waterproof products can be used for bathroom, fountain, refrigerator and other special occasions with water.

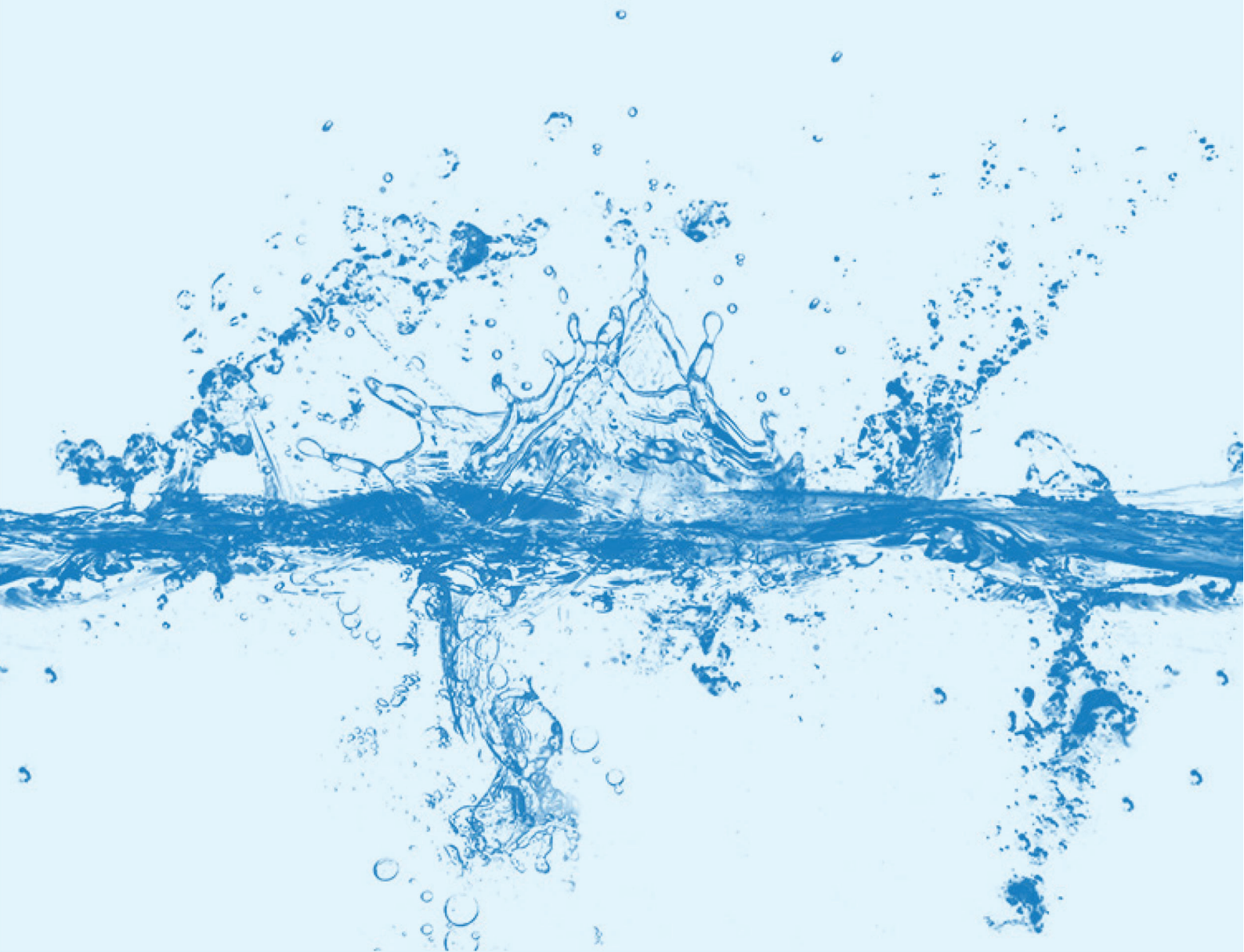





Model: LW0918N New



Material:	AL6063-T5
Surface:	Anodized/ Painting
PC cover:	Diffuser/Black
Power:	8 W/m
Input voltage:	24VDC
Lamp beads:	120LEDs/m (2835)
Lighting source width:	8 mm
Available lengths:	0.5-3m
Application:	Commercial lighting / Indoor lighting Decorative design

- Silver
- Black
- White (rat9016)

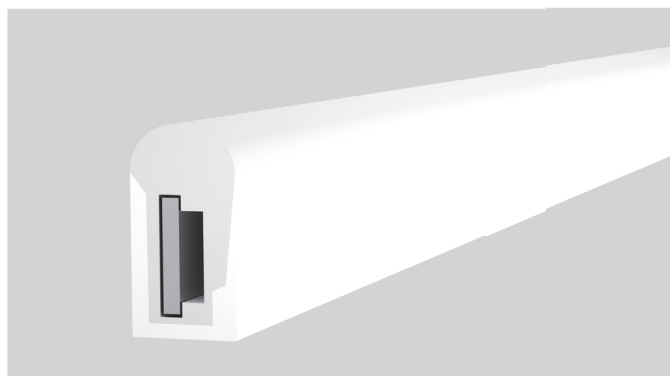

SIZE

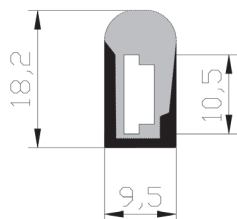



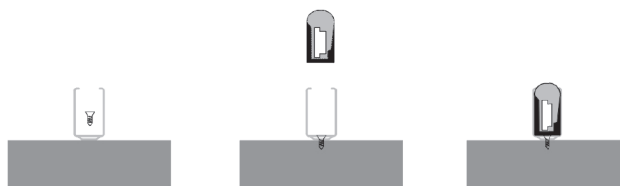

INSTALLATION

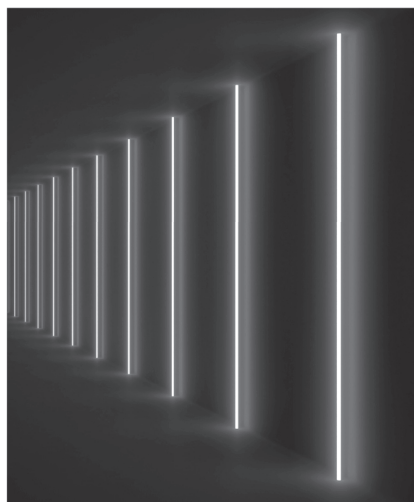

APPLICATION



COVER	Diffuser	0918N4	 Silicone
END CAP	Hole W/O hole	0918N8/0918N9	 Silicone
HEAT SINK		09185	
CLIP		0918N0	

LIGHTING SOURCE



WATERPROOF PROFILE

Model: LW1422N New



Material:	AL6063-T5
Surface:	Anodized/ Painting
PC cover:	Diffuser
Power:	8 W/m
Input voltage:	24VDC
Lamp beads:	120LEDs/m (2835)
Lighting source width:	8 mm
Available lengths:	0.5-3m
Application:	Commercial lighting / Indoor lighting Decorative design

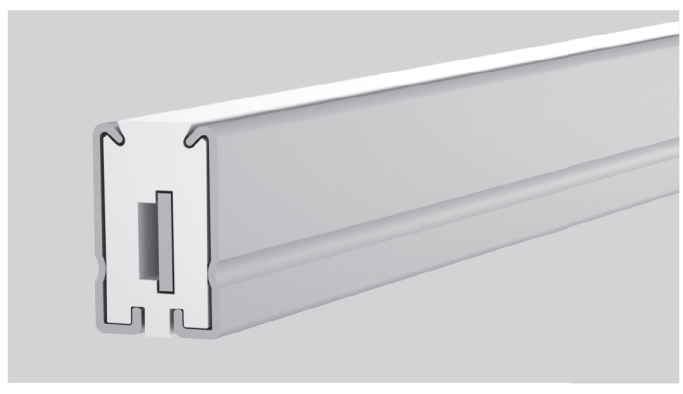

SIZE

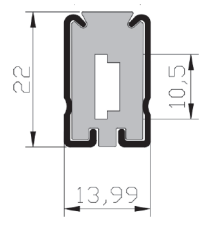

INSTALLATION

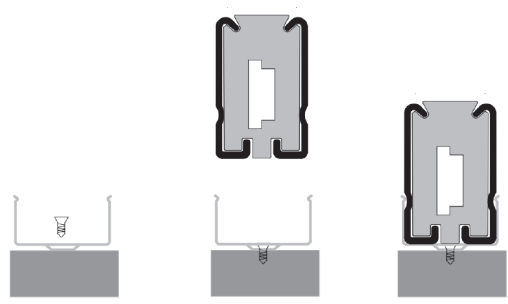

APPLICATION

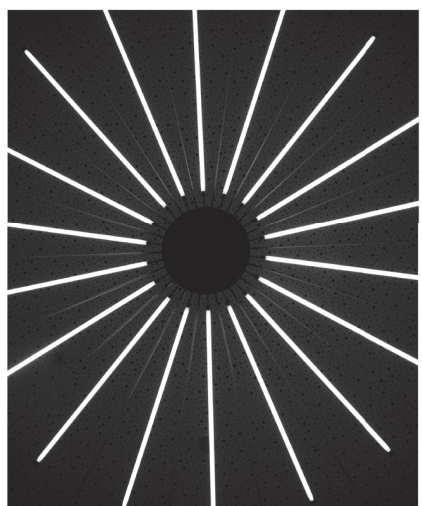

COVER	Diffuser	1422N4	Silicone
END CAP	Hole W/O hole	1422N8/1422N9	Silicone
HEAT SINK		09185	
CLIP		1422N0	

LIGHTING SOURCE

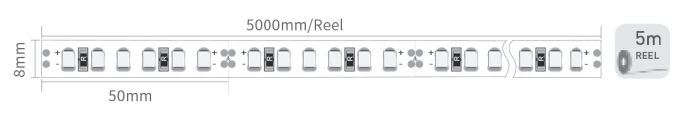

WATERPROOF PROFILE

Model: LW1716N New



Material:	AL6063-T5
Surface:	Anodized/ Painting
PC cover:	Diffuser
Power:	8 W/m
Input voltage:	24VDC
Lamp beads:	120LEDs/m (2835)
Lighting source width:	8 mm
Available lengths:	0.5-3m
Application:	Commercial lighting / Indoor lighting Decorative design

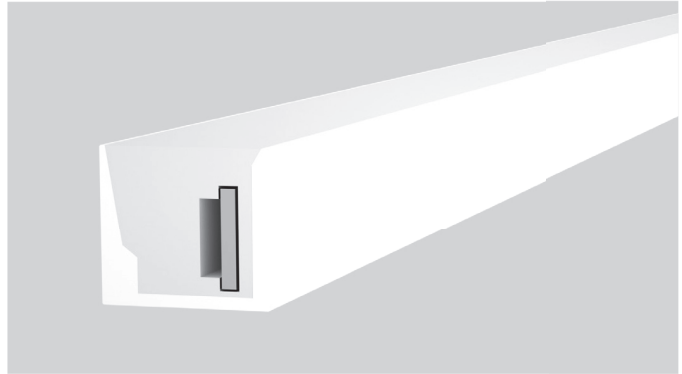

**SIZE**

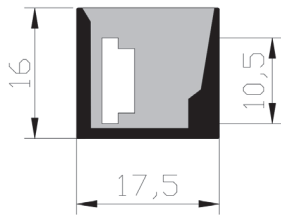

**INSTALLATION**

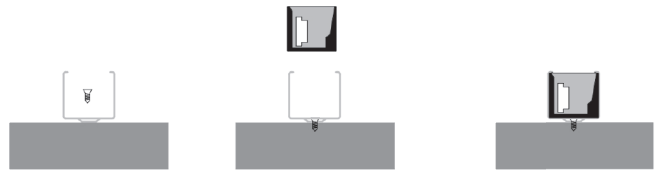

**APPLICATION**



WATERPROOF PROFILE

COVER	Diffuser	1716N4	Silicone
END CAP	Hole W/O hole	1716N8/1716N9	Silicone
HEAT SINK		09185	
CLIP		1716N0	

**LIGHTING SOURCE**



Model: LW1612N 



Material:	AL6063-T5
Surface:	Anodized/ Painting
PC cover:	Diffuser
Power:	8 W/m
Input voltage:	24VDC
Lamp beads:	120LEDs/m (2835)
Lighting source width:	8 mm
Available lengths:	0.5-3m
Application:	Commercial lighting / Indoor lighting Decorative design

 Silver
  Black
  White (RAL9016)

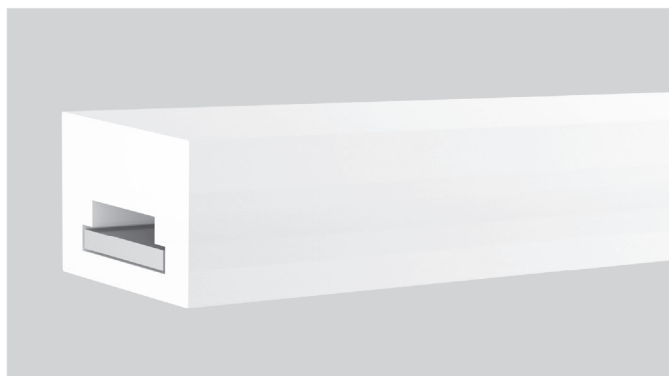

#### SIZE

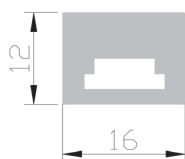



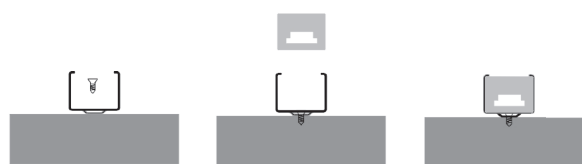

#### INSTALLATION

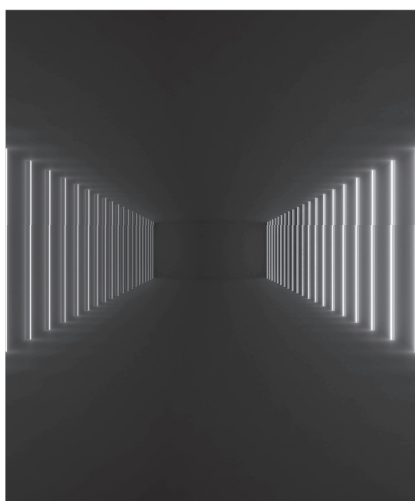

#### APPLICATION



COVER	Diffuser	1612N4	 Silicone
END CAP	Hole W/O hole	1612N8/1612N9	 Silicone
HEAT SINK		09185	
CLIP		1612N0	

#### LIGHTING SOURCE



WATERPROOF PROFILE



Model: LW2217N New



Material:	AL6063-T5
Surface:	Anodized/ Painting
PC cover:	Diffuser
Power:	8 W/m
Input voltage:	24VDC
Lamp beads:	120LEDs/m (2835)
Lighting source width:	8 mm
Available lengths:	0.5-3m
Application:	Commercial lighting / Indoor lighting Decorative design



**SIZE**

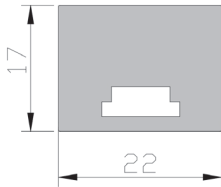

**INSTALLATION**

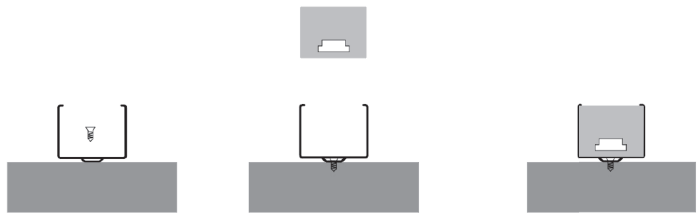

**APPLICATION**

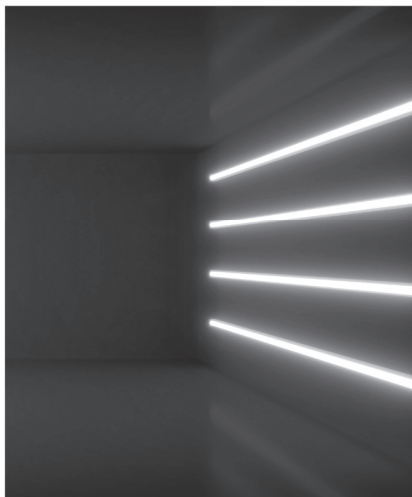

COVER	Diffuser	2217N4	Silicone
END CAP	Hole W/O hole	2217N8/2217N9	Silicone
HEAT SINK		09185	
CLIP		2217N0	

**LIGHTING SOURCE**



WATERPROOF PROFILE

Model: LW7060C New



Material:	AL6063-T5
Surface:	Anodized/ Painting
PC cover:	Diffuser
Power:	14.4 W/m
Input voltage:	24VDC
Lamp beads:	120LEDs/m (2835)
Lighting source width:	10 mm
Available lengths:	0.5-3m
Application:	Commercial lighting / Indoor lighting Decorative design

Silver
  Black
  White (RAL9016)

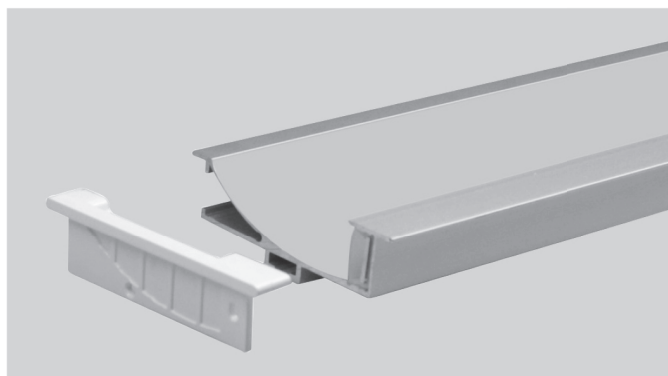

#### SIZE

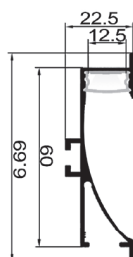



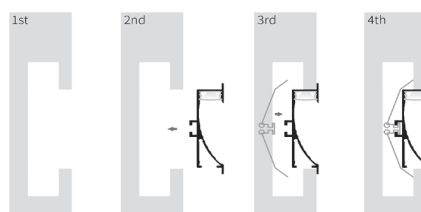

#### INSTALLATION



#### APPLICATION



COVER	Diffuser	18084	
END CAP	Hole W/O hole	7060B8/7060B9	
HEAT SINK		25205	
CLIP		25205	

#### LIGHTING SOURCE



WATERPROOF PROFILE

