

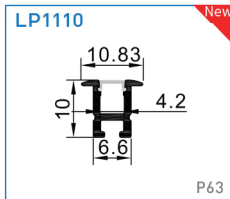

1.2

MINI PROFILE

The mini profile is made in minisize and narrow luminous surface, which can give off ultrafine light beams. This provides you a different visual experience. Less heat, high luminous efficiency, energy - saving and environmental protection. It also protects your vision.

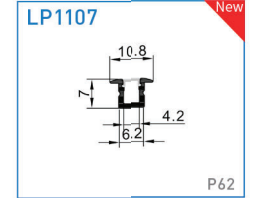
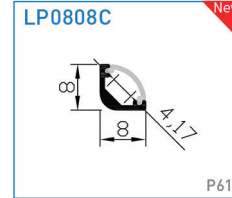
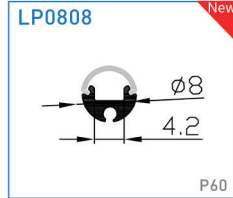
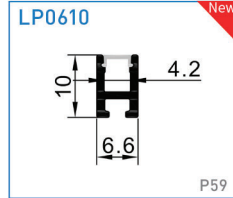
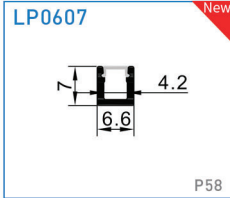

MINI LED Profile



Extremely narrow

light-emitting area Only

3.5mm

7.3mm



Thinner than a mobile phone, slim lighting source

The mini profile is made in minisize and narrow luminous surface, which can give off ultrafine light beams .This provides you a different visual experience. Less heat, high luminous efficiency, energy - saving and environmental protection. It also protects your vision.



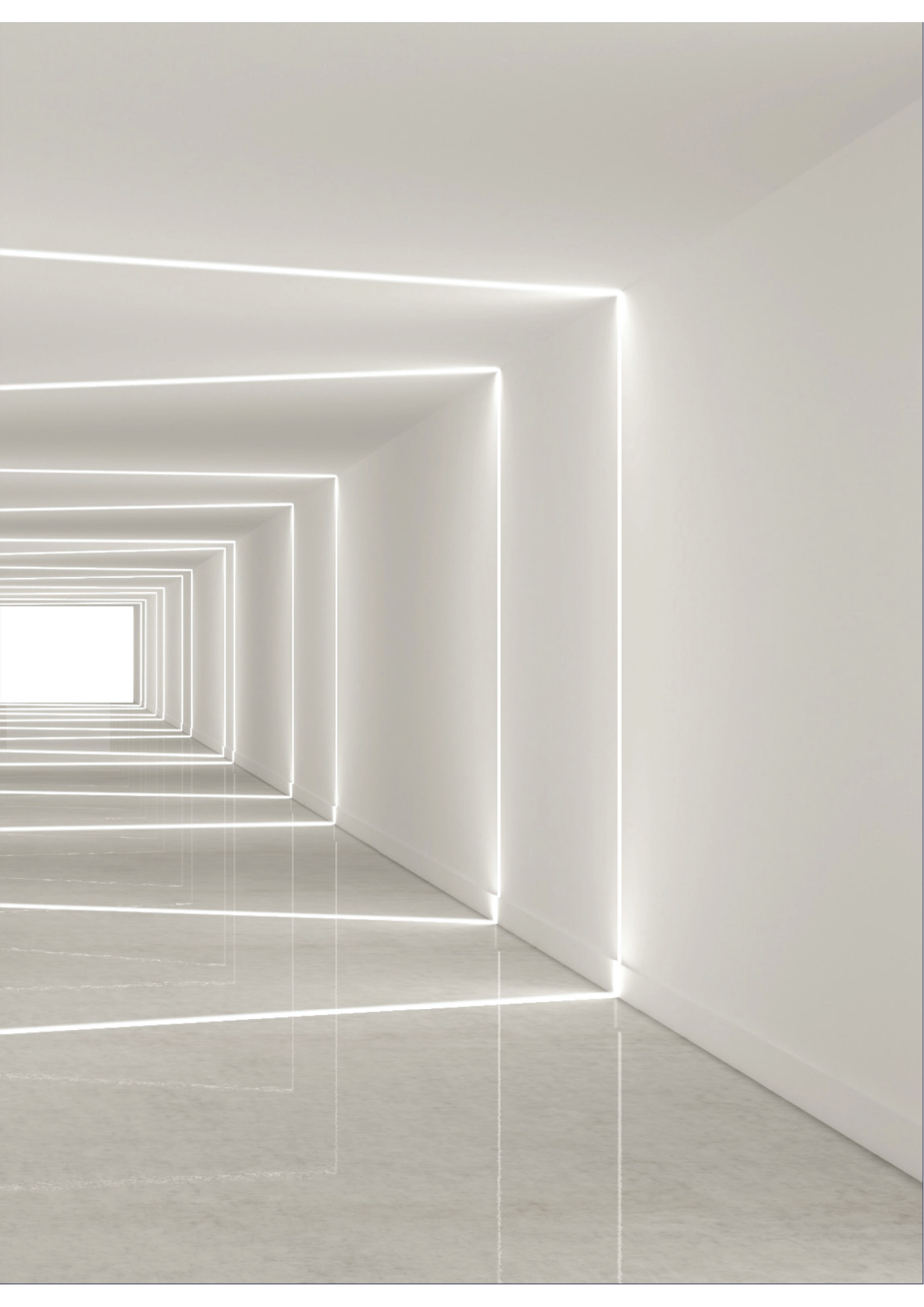

Model: *LP0607* New



IMAGE

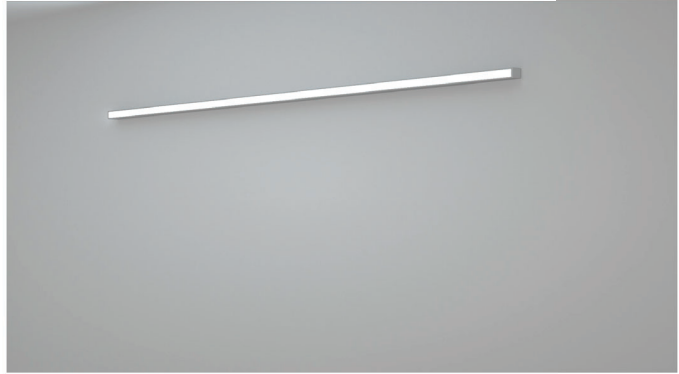
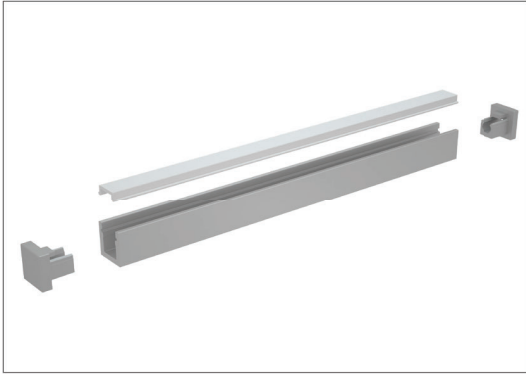

SIZE

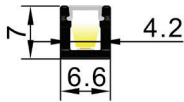

INSTALLATION

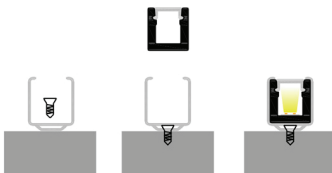

APPLICATION



Material:	AL6063-T5
Surface:	Anodized/ Painting
PC cover:	Diffuser /Transparent /Opal/Black
Power:	7.2W/m
Input voltage:	24VDC
Lamp beads:	198LEDs/m (3014)
Lighting source width:	4 mm
Available lengths:	0.5-3m
Application:	Commercial lighting / Indoor lighting

COVER	Trans/Opal/Diffuser	06072/06073 /06074	
COVER	Black	0607B	
END CAP	Hole W/O hole	06078/06079	
CLIP		06070	

LIGHTING SOURCE

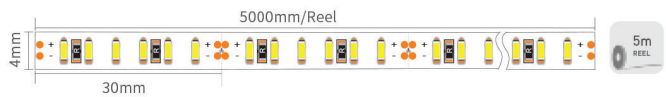

Model: LP0610 New



MINI PROFILE

IMAGE

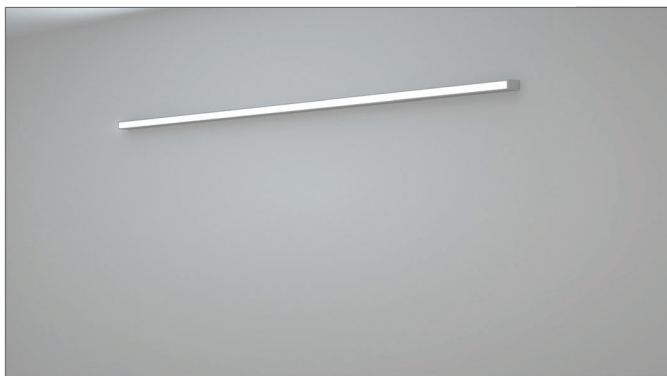

SIZE

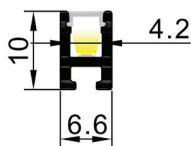

INSTALLATION

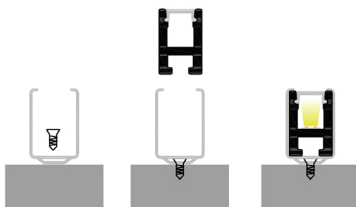

APPLICATION

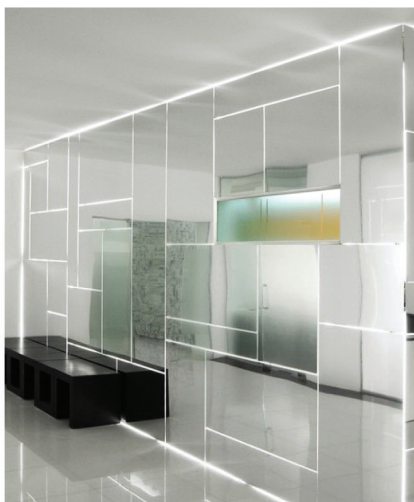

Material:	AL6063-T5
Surface:	Anodized/ Painting
PC cover:	Diffuser /Transparent /Opal/Black
Power:	7.2W/m
Input voltage:	24VDC
Lamp beads:	198LEDs/m (3014)
Lighting source width:	4 mm
Available lengths:	0.5-3m
Application:	Commercial lighting / Indoor lighting

COVER	Trans/Opal/Diffuser	06102/06103 /06104	
COVER	Black	0610B	
END CAP	Hole W/O hole	06108/06109	
CLIP		06100	

LIGHTING SOURCE

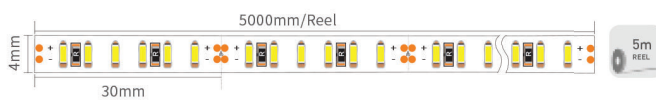

Model: *LPO808* New



IMAGE

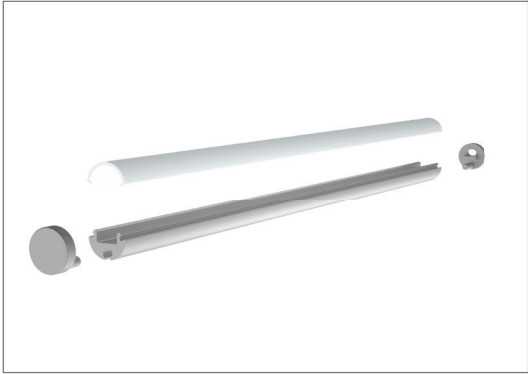

SIZE

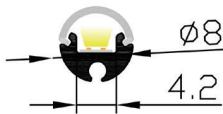

INSTALLATION



APPLICATION



Material:	AL6063-T5
Surface:	Anodized/ Painting
PC cover:	Diffuser /Transparent /Opal/Black
Power:	7.2W/m
Input voltage:	24VDC
Lamp beads:	198LEDs/m (3014)
Lighting source width:	4 mm
Available lengths:	0.5-3m
Application:	Commercial lighting / Indoor lighting

COVER	Trans/Opal/Diffuser	08082/08083/08084	
COVER	Black	0808B	
END CAP	Hole W/O hole	08088/08089	
CLIP		08080	

LIGHTING SOURCE

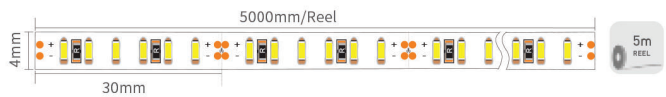

Model: LPO808C New



IMAGE



MINI PROFILE

SIZE

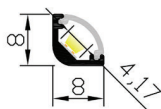

Material:	AL6063-T5
Surface:	Anodized/ Painting
PC cover:	Diffuser /Transparent /Opal/Black
Power:	7.2W/m
Input voltage:	24VDC
Lamp beads:	198LEDs/m (3014)
Lighting source width:	4 mm
Available lengths:	0.5-3m
Application:	Commercial lighting / Indoor lighting

INSTALLATION



COVER	Trans/Opal/Diffuser	0808C2/0808C3 /0808C4	
COVER	Black	0808CB	
END CAP	Hole W/O hole	0808C8/0808C9	
CLIP		0808C0	

APPLICATION

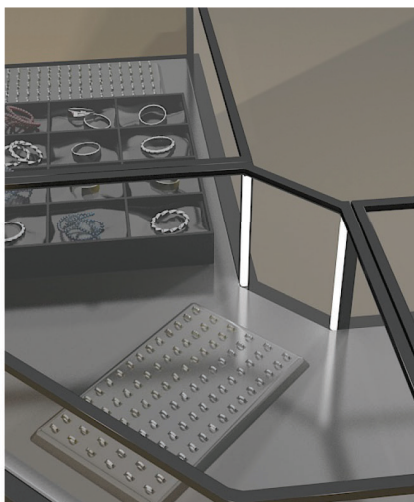

LIGHTING SOURCE

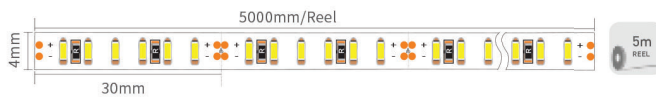

Model: LP1107 New



IMAGE

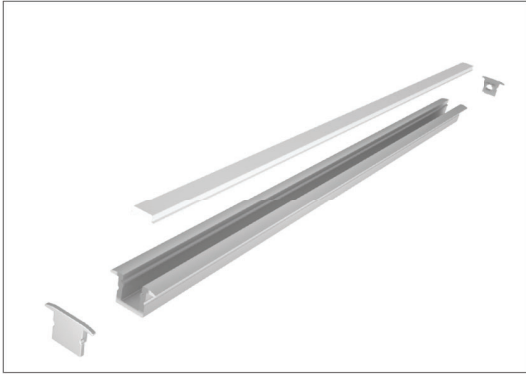

MINI PROFILE

SIZE

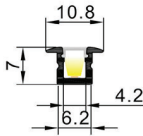

INSTALLATION



APPLICATION



Material:	AL6063-T5
Surface:	Anodized/ Painting
PC cover:	Diffuser /Transparent /Opal/Black
Power:	7.2W/m
Input voltage:	24VDC
Lamp beads:	198LEDs/m (3014)
Lighting source width:	4 mm
Available lengths:	0.5-3m
Application:	Commercial lighting / Indoor lighting

COVER	Trans/Opal/Diffuser	06072/06073 /06074	
COVER	Black	0607B	
END CAP	Hole W/O hole	11078/11079	
CLIP		11070	

LIGHTING SOURCE



Model: LP1110 New



MINI PROFILE

IMAGE

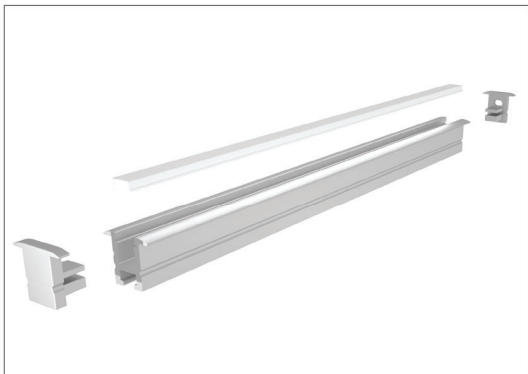

SIZE

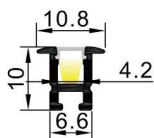

INSTALLATION

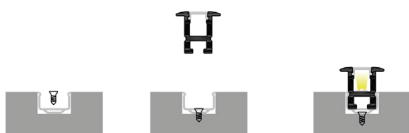

APPLICATION



Material:	AL6063-T5
Surface:	Anodized/ Painting
PC cover:	Diffuser /Transparent /Opal/Black
Power:	7.2W/m
Input voltage:	24VDC
Lamp beads:	198LEDs/m (3014)
Lighting source width:	4 mm
Available lengths:	0.5-3m
Application:	Commercial lighting / Indoor lighting

COVER	Trans/Opal/Diffuser	06072/06073 /06074	
COVER	Black	0607B	
END CAP	Hole W/O hole	11108/11109	
CLIP		11070	

LIGHTING SOURCE

